

DC-Switch Disconnectors for Photovoltaic

acc. to IEC 60364-7-712

Made in  AUSTRIA



D836E131

Contents

Page



ON-OFF Switches for Panel Mounting

4



ON-OFF Switches for Single Hole Mounting

5



ON-OFF Switches for Base Mounting with Door Clutch

6



ON-OFF Switches for Distribution Boards

7



ON-OFF Switches in Plastic Enclosure

8



Main Switches for Panel Mounting

9



Main Switches for Single Hole Mounting

10



Main Switches for Base Mounting with Door Clutch

11



Main Switches for Distribution Boards

12



Main Switches in Plastic Enclosure

13



Technical Datas

14



Dimensions

17

- 1500V DC Rated operational voltage
- 58A Rated operational current
- 2- 4- 6- and 8-pole
- Oxydation proof contacts
- Cable cross sections up to 16mm²

Type	I _{th} open A	DC21B 4 poles in series A	at U _e V
LS16	16	16	1000
LS25	25	25	1000
LS32	32	32	1000

DC-Switch Disconnectors

Panel mounting



Single hole mounting
Ø22,5mm



Base mounting
w. door coupling



Modular switch



Plastic enclosed



Type	Panel mounting	Single hole mounting	Base mounting w. door coupling	Modular switch	Plastic enclosed
LS16	.. E Z(O) VZV SMA PFL ..
LS25	.. E Z(O) VZV SMA PFL ..
LS32	.. E Z(O) VZV SMA PFL ..

Switch Disconnectors for Photovoltaic

Switch disconnectors „LS..“ are switch gears for interrupting the DC/AC-Inverter from the solar-panels. Photovoltaic-installations have to be equipped with DC-isolators according to IEC 60364-7-712.

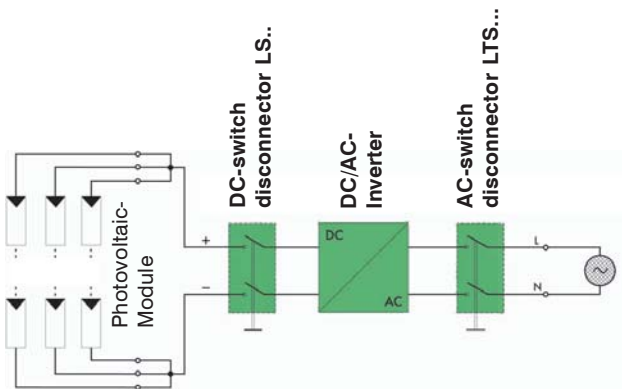

Switch disconnectors „LS..“ ensures a reliable switching up to 58A with 1000V in the category DC21B.

The construction of the contacts and the material selection guarantee that no oxidation (small switching frequency) develops, and is thus prevented inadmissible heating-up.

The switch disconnecter has 2, 4, 6 or 8 contacts, by serial or parallel wiring of the contacts the contact rating will be increased.

The switching speed at the manually operated handle does not have an effect on the switching attitude of the contacts.

Switching programs

Type	2-pole	2+2-pole 2 poles in series +2 poles parallel	4-pole	4-pole with jumpers Input on top Output bottom	4-pole with jumpers Input and Output bottom	4-pole with jumpers Input and Output on top
LS16	.. A2	.. A2+2	.. A4	.. A4B	.. A4O	.. A4U
LS25	.. A2	.. A2+2	.. A4	.. A4B	.. A4O	.. A4U
LS32	.. A2	.. A2+2	.. A4	.. A4B	.. A4O	.. A4U

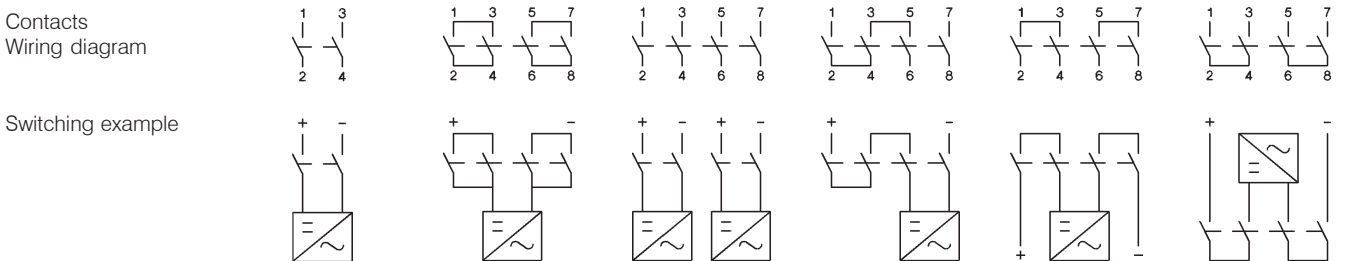

Ordering

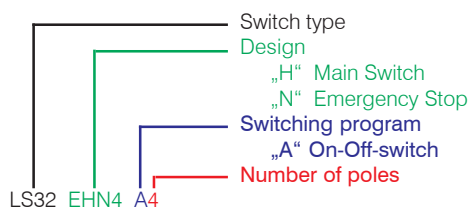

DC-Main Switch

Panel mounting



Single hole mounting
Ø22,5mm



Base mounting
with door coupling



Modular switch



Plastic enclosed



.. EH4 Z(O)H1 VZVH4 SMAH1 PFLH4 ..
.. EH4 Z(O)H1 VZVH4 SMAH1 PFLH4 ..
.. EH4 Z(O)H1 VZVH4 SMAH1 PFLH4 ..

Technical data for DC, according to IEC 60947-3, VDE0660

Type	DC21B						DC22B					
	500V	600V	700V	800V	900V	1000V	500V	600V	800V	1000V		
LS16 ..		2 poles in series	16A	16A	16A	16A	13A	9A	7A	5,5A	2A	1A
		2 poles in series+2 parallel	29A	29A	16A	16A	13A	9A	-	-	-	-
		4 poles in series	16A	16A	16A	16A	16A	16A	16A	16A	11,5A	8A
		4 poles in series+2 parallel	29A	29A	29A	29A	29A	29A	29A	-	-	-
LS25 ..		2 poles in series	25A	25A	23A	20A	16A	11A	8A	6A	2,5A	1,5A
		2 poles in series+2 parallel	45A	45A	23A	20A	16A	11A	-	-	-	-
		4 poles in series	25A	25A	25A	25A	25A	25A	25A	25A	12A	9A
		4 poles in series+2 parallel	45A	45A	45A	45A	45A	45A	45A	-	-	-
LS32 ..		2 poles in series	32A	32A	27A	23A	20A	13A	9A	6,5A	3A	2A
		2 poles in series+2 parallel	58A	50A	27A	23A	20A	13A	-	-	-	-
		4 poles in series	32A	32A	32A	32A	32A	32A	32A	27,5A	12,5A	10A
		4 poles in series+2 parallel	58A	58A	58A	58A	58A	58A	58A	-	-	-

DC21B Switching of DC-resistive loads including moderate overloads, Time constant $L/R \leq 1\text{ms}$

DC22B Switching of DC-resistive and inductive loads including moderate overloads, Time constant $L/R \leq 2,5\text{ms}$
(e. g: shunt-motors)

Switching programs







Type	6-pole	3+2-pole 3 poles in series +2 poles parallel	8-pole	4+2-pole 4 poles in series +2 poles parallel
LS16	...A6	.. A3+2	...A8	.. A4+2
LS25	...A6	.. A3+2	...A8	.. A4+2
LS32	...A6	.. A3+2	...A8	.. A4+2
Contacts Wiring diagram				
Switching example				

Insulated Jumper LSV-B1 for series and parallel switching of contacts

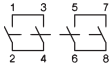
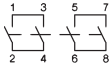

Type	Pack	Weight
LSV-B1	100	6,6 g/pc.

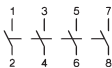
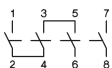
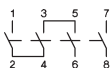
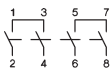
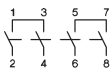
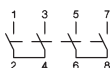
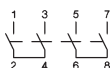

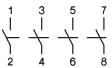
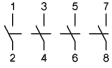
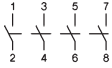
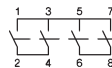
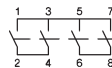



ON-OFF Switches for Panel Mounting, Escutcheon plate 64□, IP66, cULus Typ 3R

		DC21B 600V DC	1000V DC	Poles in series	Number of Strings	Type	Pack pcs	Weight kg/pcs.
		16A	9A	2	1	LS16 E A2	1	0,20
		25A	11A	2	1	LS25 E A2	1	0,20
		32A	13A	2	1	LS32 E A2	1	0,20
		29A	9A	2	1	LS16 E A2+2	1	0,25
		45A	11A	2	1	LS25 E A2+2	1	0,25
		50A	13A	2	1	LS32 E A2+2	1	0,25
		16A	9A	2	2	LS16 E A4	1	0,23
		25A	11A	2	2	LS25 E A4	1	0,23
		32A	13A	2	2	LS32 E A4	1	0,23
		16A	16A	4	1	LS16 E A4B	1	0,24
		25A	25A	4	1	LS25 E A4B	1	0,24
		32A	32A	4	1	LS32 E A4B	1	0,24
		16A	16A	4	1	LS16 E A4O	1	0,24
		25A	25A	4	1	LS25 E A4O	1	0,24
		32A	32A	4	1	LS32 E A4O	1	0,24
		16A	16A	4	1	LS16 E A4U	1	0,24
		25A	25A	4	1	LS25 E A4U	1	0,24
		32A	32A	4	1	LS32 E A4U	1	0,24
		16A	9A	2	3	LS16 E A6	1	0,36
		25A	11A	2	3	LS25 E A6	1	0,36
		32A	13A	2	3	LS32 E A6	1	0,36
		16A	9A	2	4	LS16 E A8	1	0,41
		25A	11A	2	4	LS25 E A8	1	0,41
		32A	13A	2	4	LS32 E A8	1	0,41
		29A	29A	4	1	LS16 E A4+2	1	0,46
		45A	45A	4	1	LS25 E A4+2	1	0,46
		58A	58A	4	1	LS32 E A4+2	1	0,46

Extended Switch Shaft for all switches for panel mounting

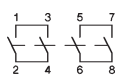
type suffix **+VW"x"** x = panel thickness

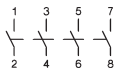
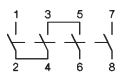
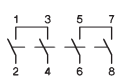
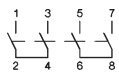
ON-OFF Switches for Single Hole Mounting Ø22mm, Escutcheon plate 48□, IP66, cULus Typ 3R

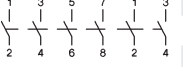
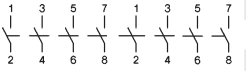
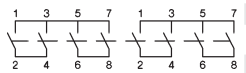
		DC21B 600V DC	1000V DC	Poles in series	Number of Strings	Type	Pack pcs	Weight kg/pcs.	
		16A	9A	2	1	LS16 Z A2	1	0,21	
		25A	11A	2	1	LS25 Z A2	1	0,21	
		32A	13A	2	1	LS32 Z A2	1	0,21	
		29A	9A	2	1	LS16 Z A2+2	1	0,26	
		45A	11A	2	1	LS25 Z A2+2	1	0,26	
		50A	13A	2	1	LS32 Z A2+2	1	0,26	
		16A	9A	2	2	LS16 Z A4	1	0,23	
		25A	11A	2	2	LS25 Z A4	1	0,23	
		32A	13A	2	2	LS32 Z A4	1	0,23	
		16A	16A	4	1	LS16 Z A4B	1	0,25	
		25A	25A	4	1	LS25 Z A4B	1	0,25	
		32A	32A	4	1	LS32 Z A4B	1	0,25	
		16A	16A	4	1	LS16 Z A4O	1	0,25	
		25A	25A	4	1	LS25 Z A4O	1	0,25	
		32A	32A	4	1	LS32 Z A4O	1	0,25	
		16A	16A	4	1	LS16 Z A4U	1	0,25	
		25A	25A	4	1	LS25 Z A4U	1	0,25	
		32A	32A	4	1	LS32 Z A4U	1	0,25	
			16A	9A	2	3	LS16 Z A6	1	0,38
			25A	11A	2	3	LS25 Z A6	1	0,38
			32A	13A	2	3	LS32 Z A6	1	0,38
			16A	9A	2	4	LS16 Z A8	1	0,43
			25A	11A	2	4	LS25 Z A8	1	0,43
			32A	13A	2	4	LS32 Z A8	1	0,43
		29A	29A	4	1	LS16 Z A4+2	1	0,48	
		45A	45A	4	1	LS25 Z A4+2	1	0,48	
		58A	58A	4	1	LS32 Z A4+2	1	0,48	

ON-OFF Switches for Single Hole Mounting Ø22mm, without Escutcheon plate, IP66, cULus Typ 3R¹⁾

Replace at the Type „Z“ with „ZO“ **LS.. ZO A.**

ON-OFF Switches f. Base Mounting w. Door Clutch f. Single Hole, Plate 64[□], IP66, c us Typ 3R







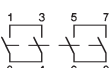
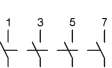
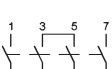
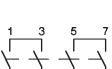
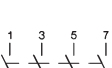
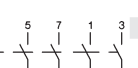
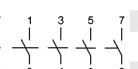
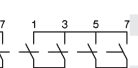

Depth is adjustable
see page 24

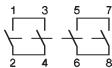

	DC21B 600V DC	1000V DC	Poles in series	Number of Strings	Type	Pack pcs	Weight kg/pcs.
	16A	9A	2	1	LS16 VZV A2	1	0,22
	25A	11A	2	1	LS25 VZV A2	1	0,22
	32A	13A	2	1	LS32 VZV A2	1	0,22
	29A	9A	2	1	LS16 VZV A2+2	1	0,27
	45A	11A	2	1	LS25 VZV A2+2	1	0,27
	50A	13A	2	1	LS32 VZV A2+2	1	0,27
	16A	9A	2	2	LS16 VZV A4	1	0,25
	25A	11A	2	2	LS25 VZV A4	1	0,25
	32A	13A	2	2	LS32 VZV A4	1	0,25
	16A	16A	4	1	LS16 VZV A4B	1	0,26
	25A	25A	4	1	LS25 VZV A4B	1	0,26
	32A	32A	4	1	LS32 VZV A4B	1	0,26
	16A	16A	4	1	LS16 VZV A4O	1	0,26
	25A	25A	4	1	LS25 VZV A4O	1	0,26
	32A	32A	4	1	LS32 VZV A4O	1	0,26
	16A	16A	4	1	LS16 VZV A4U	1	0,26
	25A	25A	4	1	LS25 VZV A4U	1	0,26
	32A	32A	4	1	LS32 VZV A4U	1	0,26
	16A	9A	2	3	LS16 VZV A6	1	0,38
	25A	11A	2	3	LS25 VZV A6	1	0,38
	32A	13A	2	3	LS32 VZV A6	1	0,38
	16A	9A	2	4	LS16 VZV A8	1	0,43
	25A	11A	2	4	LS25 VZV A8	1	0,43
	32A	13A	2	4	LS32 VZV A8	1	0,43
	29A	29A	4	1	LS16 VZV A4+2	1	0,48
	45A	45A	4	1	LS25 VZV A4+2	1	0,48
	58A	58A	4	1	LS32 VZV A4+2	1	0,48

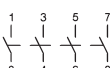
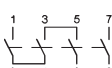
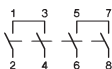
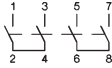
ON-OFF Switches for Distribution Boards, IP40, cULus Typ 1

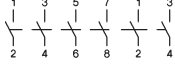
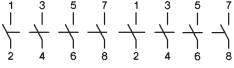
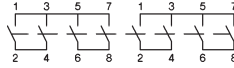
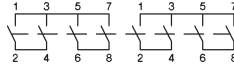
		DC21B 600V DC	1000V DC	Poles in series	Number of Strings	Type	Pack pcs	Weight kg/pcs.	
		16A	9A	2	1	LS16 SMA A2	1	0,19	
		25A	11A	2	1	LS25 SMA A2	1	0,19	
		32A	13A	2	1	LS32 SMA A2	1	0,19	
		29A	9A	2	1	LS16 SMA A2+2	1	0,24	
		45A	11A	2	1	LS25 SMA A2+2	1	0,24	
		50A	13A	2	1	LS32 SMA A2+2	1	0,24	
		16A	9A	2	2	LS16 SMA A4	1	0,22	
		25A	11A	2	2	LS25 SMA A4	1	0,22	
		32A	13A	2	2	LS32 SMA A4	1	0,22	
		16A	16A	4	1	LS16 SMA A4B	1	0,23	
		25A	25A	4	1	LS25 SMA A4B	1	0,23	
		32A	32A	4	1	LS32 SMA A4B	1	0,23	
		16A	16A	4	1	LS16 SMA A4O	1	0,23	
		25A	25A	4	1	LS25 SMA A4O	1	0,23	
		32A	32A	4	1	LS32 SMA A4O	1	0,23	
		16A	16A	4	1	LS16 SMA A4U	1	0,23	
		25A	25A	4	1	LS25 SMA A4U	1	0,23	
		32A	32A	4	1	LS32 SMA A4U	1	0,23	
			16A	9A	2	3	LS16 SMA A6	1	0,35
			25A	11A	2	3	LS25 SMA A6	1	0,35
			32A	13A	2	3	LS32 SMA A6	1	0,35
			16A	9A	2	4	LS16 SMA A8	1	0,40
			25A	11A	2	4	LS25 SMA A8	1	0,40
			32A	13A	2	4	LS32 SMA A8	1	0,40
		29A	29A	4	1	LS16 SMA A4+2	1	0,43	
		45A	45A	4	1	LS25 SMA A4+2	1	0,43	
		58A	58A	4	1	LS32 SMA A4+2	1	0,43	

ON-OFF Switches in Plastic Enclosure, Escutcheon plate 64□, IP65, cULus Typ 1









	DC21B 600V DC	1000V DC	Poles in series	Number of Strings	Type	Pack pcs	Weight kg/pcs.
	16A	9A	2	1	LS16 PFL A2 *)	1	0,42
	25A	11A	2	1	LS25 PFL A2 *)	1	0,42
	32A	13A	2	1	LS32 PFL A2 *)	1	0,42
	29A	9A	2	1	LS16 PFL A2+2 *)	1	0,48
	45A	11A	2	1	LS25 PFL A2+2 *)	1	0,48
	50A	13A	2	1	LS32 PFL A2+2 *)	1	0,48
	16A	9A	2	2	LS16 PFL A4 *)	1	0,45
	25A	11A	2	2	LS25 PFL A4 *)	1	0,45
	32A	13A	2	2	LS32 PFL A4 *)	1	0,45
	16A	16A	4	1	LS16 PFL A4B *)	1	0,46
	25A	25A	4	1	LS25 PFL A4B *)	1	0,46
	32A	32A	4	1	LS32 PFL A4B *)	1	0,46
	16A	16A	4	1	LS16 PFL A4O *)	1	0,46
	25A	25A	4	1	LS25 PFL A4O *)	1	0,46
	32A	32A	4	1	LS32 PFL A4O *)	1	0,46
	16A	16A	4	1	LS16 PFL A4U *)	1	0,46
	25A	25A	4	1	LS25 PFL A4U *)	1	0,46
	32A	32A	4	1	LS32 PFL A4U *)	1	0,46
	16A	9A	2	3	LS16 PF A6	1	1,52
	25A	11A	2	3	LS25 PF A6	1	1,52
	32A	13A	2	3	LS32 PF A6	1	1,52
	16A	9A	2	4	LS16 PF A8	1	1,57
	25A	11A	2	4	LS25 PF A8	1	1,57
	32A	13A	2	4	LS32 PF A8	1	1,57
	29A	29A	4	1	LS16 PF A4+2	1	1,62
	45A	45A	4	1	LS25 PF A4+2	1	1,62
	58A	58A	4	1	LS32 PF A4+2	1	1,62

*) Version with **small** enclosure PF possible

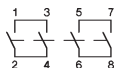
Ordering example: **standard** enclosure LS.. PFL A..
small enclosure LS.. PF A..

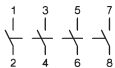
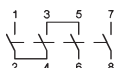
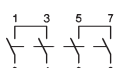
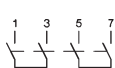

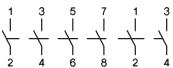
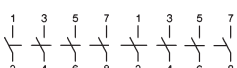
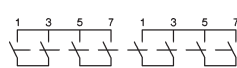



Main Switches for Panel Mounting, Escutcheon plate 64□, IP66, cULus Typ 3R

		DC21B 600V DC	1000V DC	Poles in series	Number of Strings	Type	Pack pcs	Weight kg/pcs.
		16A	9A	2	1	LS16 EH4 A2	1	0,21
		25A	11A	2	1	LS25 EH4 A2	1	0,21
		32A	13A	2	1	LS32 EH4 A2	1	0,21
padlock device SV4		29A	9A	2	1	LS16 EH4 A2+2	1	0,26
		45A	11A	2	1	LS25 EH4 A2+2	1	0,26
		50A	13A	2	1	LS32 EH4 A2+2	1	0,26
		16A	9A	2	2	LS16 EH4 A4	1	0,24
		25A	11A	2	2	LS25 EH4 A4	1	0,24
		32A	13A	2	2	LS32 EH4 A4	1	0,24
		16A	9A	4	1	LS16 EH4 A4B	1	0,25
		25A	11A	4	1	LS25 EH4 A4B	1	0,25
		32A	13A	4	1	LS32 EH4 A4B	1	0,25
		16A	16A	4	1	LS16 EH4 A4O	1	0,25
		25A	25A	4	1	LS25 EH4 A4O	1	0,25
		32A	32A	4	1	LS32 EH4 A4O	1	0,25
		16A	16A	4	1	LS16 EH4 A4U	1	0,25
		25A	25A	4	1	LS25 EH4 A4U	1	0,25
		32A	32A	4	1	LS32 EH4 A4U	1	0,25
		16A	9A	2	3	LS16 EH4 A6	1	0,37
		25A	11A	2	3	LS25 EH4 A6	1	0,37
		32A	13A	2	3	LS32 EH4 A6	1	0,37
	16A	9A	2	4	LS16 EH4 A8	1	0,42	
	25A	11A	2	4	LS25 EH4 A8	1	0,42	
	32A	13A	2	4	LS32 EH4 A8	1	0,42	
	29A	29A	4	1	LS16 EH4 A4+2	1	0,47	
	45A	45A	4	1	LS25 EH4 A4+2	1	0,47	
	58A	58A	4	1	LS32 EH4 A4+2	1	0,47	

Extended Switch Shaft for all switches for panel mounting

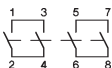
type suffix +VW"x" x = panel thickness

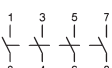
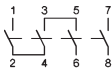
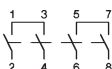
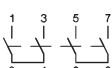

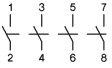
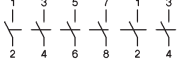
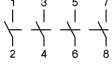
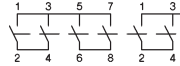
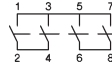













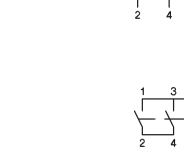

Main Switches for Single Hole Mounting Ø22mm, Escutcheon plate 48³, IP66, c³us Typ 3R

	DC21B 600V DC	1000V DC	Poles in series	Number of Strings	Type	Pack pcs	Weight kg/pcs.		
		16A	9A	2	1	LS16 ZH1 A2	1	0,21	
		25A	11A	2	1	LS25 ZH1 A2	1	0,21	
		32A	13A	2	1	LS32 ZH1 A2	1	0,21	
padlock device SV1		29A	9A	2	1	LS16 ZH1 A2+2	1	0,27	
		45A	11A	2	1	LS25 ZH1 A2+2	1	0,27	
		50A	13A	2	1	LS32 ZH1 A2+2	1	0,27	
		16A	9A	2	2	LS16 ZH1 A4	1	0,24	
		25A	11A	2	2	LS25 ZH1 A4	1	0,24	
		32A	13A	2	2	LS32 ZH1 A4	1	0,24	
		16A	16A	4	1	LS16 ZH1 A4B	1	0,25	
		25A	25A	4	1	LS25 ZH1 A4B	1	0,25	
		32A	32A	4	1	LS32 ZH1 A4B	1	0,25	
		16A	16A	4	1	LS16 ZH1 A4O	1	0,25	
		25A	25A	4	1	LS25 ZH1 A4O	1	0,25	
		32A	32A	4	1	LS32 ZH1 A4O	1	0,25	
		16A	16A	4	1	LS16 ZH1 A4U	1	0,25	
		25A	25A	4	1	LS25 ZH1 A4U	1	0,25	
		32A	32A	4	1	LS32 ZH1 A4U	1	0,25	
			16A	9A	2	3	LS16 ZH1 A6	1	0,39
			25A	11A	2	3	LS25 ZH1 A6	1	0,39
			32A	13A	2	3	LS32 ZH1 A6	1	0,39
		16A	9A	2	4	LS16 ZH1 A8	1	0,44	
		25A	11A	2	4	LS25 ZH1 A8	1	0,44	
		32A	13A	2	4	LS32 ZH1 A8	1	0,44	
		29A	29A	4	1	LS16 ZH1 A4+2	1	0,49	
		45A	45A	4	1	LS25 ZH1 A4+2	1	0,49	
		58A	58A	4	1	LS32 ZH1 A4+2	1	0,49	

Main Switches for Single Hole Mounting Ø22mm, without Escutcheon plate, IP66, c³us Typ 3R¹⁾





Replace at the Type „ZH1“ with „ZOH1“ LS.. ZOH1 A.

Main Switches f. Base Mounting, Door Clutch f. Single Hole, Escutcheon plate 64□, IP66, cULus Typ 3R

		DC21B 600V DC	1000V DC	Poles in series	Number of Strings	Type	Pack pcs	Weigth kg/pcs.
		16A	9A	2	1	LS16 VZVH4 A2	1	0,23
		25A	11A	2	1	LS25 VZVH4 A2	1	0,23
		32A	13A	2	1	LS32 VZVH4 A2	1	0,23
		29A	9A	2	1	LS16 VZVH4 A2+2	1	0,28
		45A	11A	2	1	LS25 VZVH4 A2+2	1	0,28
		50A	13A	2	1	LS32 VZVH4 A2+2	1	0,28
		16A	9A	2	2	LS16 VZVH4 A4	1	0,26
		25A	11A	2	2	LS25 VZVH4 A4	1	0,26
		32A	13A	2	2	LS32 VZVH4 A4	1	0,26
		16A	16A	4	1	LS16 VZVH4 A4B	1	0,27
		25A	25A	4	1	LS25 VZVH4 A4B	1	0,27
		32A	32A	4	1	LS32 VZVH4 A4B	1	0,27
		16A	16A	4	1	LS16 VZVH4 A4O	1	0,27
		25A	25A	4	1	LS25 VZVH4 A4O	1	0,27
		32A	32A	4	1	LS32 VZVH4 A4O	1	0,27
		16A	16A	4	1	LS16 VZVH4 A4U	1	0,27
		25A	25A	4	1	LS25 VZVH4 A4U	1	0,27
		32A	32A	4	1	LS32 VZVH4 A4U	1	0,27
		16A	9A	2	3	LS16 VZVH4 A6	1	0,39
		25A	11A	2	3	LS25 VZVH4 A6	1	0,39
		32A	13A	2	3	LS32 VZVH4 A6	1	0,39
		16A	9A	2	4	LS16 VZVH4 A8	1	0,44
		25A	11A	2	4	LS25 VZVH4 A8	1	0,44
		32A	13A	2	4	LS32 VZVH4 A8	1	0,44
		29A	29A	4	1	LS16 VZVH4 A4+2	1	0,49
		45A	45A	4	1	LS25 VZVH4 A4+2	1	0,49
		58A	58A	4	1	LS32 VZVH4 A4+2	1	0,49

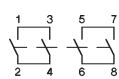
Depth is adjustable
see page 24
padlock device SV4

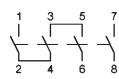
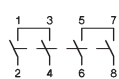
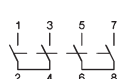
Main Switches for Distribution Boards, IP40, cULus Typ 1

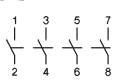
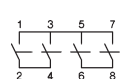
		DC21B 600V DC	1000V DC	Poles in series	Number of Strings	Type	Pack pcs	Weight kg/pcs.	
 padlock device SV1		16A	9A	2	1	LS16 SMAH1 A2	1	0,19	
		25A	11A	2	1	LS25 SMAH1 A2	1	0,19	
		32A	13A	2	1	LS32 SMAH1 A2	1	0,19	
		29A	9A	2	1	LS16 SMAH1 A2+2	1	0,25	
		45A	11A	2	1	LS25 SMAH1 A2+2	1	0,25	
		50A	13A	2	1	LS32 SMAH1 A2+2	1	0,25	
		16A	9A	2	2	LS16 SMAH1 A4	1	0,22	
		25A	11A	2	2	LS25 SMAH1 A4	1	0,22	
		32A	13A	2	2	LS32 SMAH1 A4	1	0,22	
		16A	16A	4	1	LS16 SMAH1 A4B	1	0,23	
		25A	25A	4	1	LS25 SMAH1 A4B	1	0,23	
		32A	32A	4	1	LS32 SMAH1 A4B	1	0,23	
		16A	16A	4	1	LS16 SMAH1 A4O	1	0,23	
		25A	25A	4	1	LS25 SMAH1 A4O	1	0,23	
		32A	32A	4	1	LS32 SMAH1 A4O	1	0,23	
		16A	16A	4	1	LS16 SMAH1 A4U	1	0,23	
		25A	25A	4	1	LS25 SMAH1 A4U	1	0,23	
		32A	32A	4	1	LS32 SMAH1 A4U	1	0,23	
			16A	9A	2	3	LS16 SMAH1 A6	1	0,36
			25A	11A	2	3	LS25 SMAH1 A6	1	0,36
			32A	13A	2	3	LS32 SMAH1 A6	1	0,36
			16A	9A	2	4	LS16 SMAH1 A8	1	0,41
			25A	11A	2	4	LS25 SMAH1 A8	1	0,41
			32A	13A	2	4	LS32 SMAH1 A8	1	0,41
	29A	29A	4	1	LS16 SMAH1 A4+2	1	0,46		
	45A	45A	4	1	LS25 SMAH1 A4+2	1	0,46		
	58A	58A	4	1	LS32 SMAH1 A4+2	1	0,46		

Main Switches in Plastic Enclosure Escutcheon plate 64□, IP65, c us Typ 1

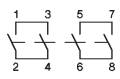
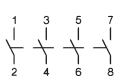
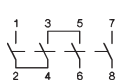
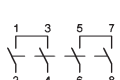
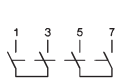
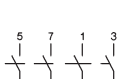
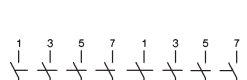
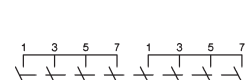

padlock device SV4

	DC21B 600V DC	1000V DC	Poles in series	Number of Strings	Type	Pack pcs	Weight kg/pcs.
	16A	9A	2	1	LS16 PFLH4 A2 *)	1	0,43
	25A	11A	2	1	LS25 PFLH4 A2 *)	1	0,43
	32A	13A	2	1	LS32 PFLH4 A2 *)	1	0,43
	29A	9A	2	1	LS16 PFLH4 A2+2 *)	1	0,49
	45A	11A	2	1	LS25 PFLH4 A2+2 *)	1	0,49
	50A	13A	2	1	LS32 PFLH4 A2+2 *)	1	0,49
	16A	9A	2	2	LS16 PFLH4 A4 *)	1	0,46
	25A	11A	2	2	LS25 PFLH4 A4 *)	1	0,46
	32A	13A	2	2	LS32 PFLH4 A4 *)	1	0,46
	16A	16A	4	1	LS16 PFLH4 A4B *)	1	0,47
	25A	25A	4	1	LS25 PFLH4 A4B *)	1	0,47
	32A	32A	4	1	LS32 PFLH4 A4B *)	1	0,47
	16A	16A	4	1	LS16 PFLH4 A4O *)	1	0,47
	25A	25A	4	1	LS25 PFLH4 A4O *)	1	0,47
	32A	32A	4	1	LS32 PFLH4 A4O *)	1	0,47
	16A	16A	4	1	LS16 PFLH4 A4U *)	1	0,47
	25A	25A	4	1	LS25 PFLH4 A4U *)	1	0,47
	32A	32A	4	1	LS32 PFLH4 A4U *)	1	0,47
	16A	9A	2	3	LS16 PFH4 A6	1	1,53
	25A	11A	2	3	LS25 PFH4 A6	1	1,53
	32A	13A	2	3	LS32 PFH4 A6	1	1,53
	16A	9A	2	4	LS16 PFH4 A8	1	1,58
	25A	11A	2	4	LS25 PFH4 A8	1	1,58
	32A	13A	2	4	LS32 PFH4 A8	1	1,58
	29A	29A	4	1	LS16 PFH4 A4+2	1	1,63
	45A	45A	4	1	LS25 PFH4 A4+2	1	1,63
	58A	58A	4	1	LS32 PFH4 A4+2	1	1,63

*) Version with **small** enclosure PF possible

Ordering example: **standard** enclosure LS.. PFL A..
small enclosure LS.. PF A..

Technical Datas

Data according to IEC 60947-3, VDE 0660, GB14048.3 (CCC China)





Main contacts		Type	LS16	LS25	LS32	
Rated thermal current I_{the}		A	16	25	32	
Rated insulation voltage U_i ¹⁾		V	1000	1000	1000	
Rated insulation voltage U_i ²⁾		V	1500	1500	1500	
Distance of contacts (per pole)		mm	8	8	8	
Rated operational current I_e						
DC21A and DC21B	1 pole	A	16	23	27	
	A1	A	12	14	16	
		A	9	11	13	
		A	6	8	10	
		A	4,5	6	7,5	
		A	3	4	5	
		A	2,5	3	4	
		A	1,5	2	2,5	
	DC21B	2 pole in series	A	16	25	32
		A2	A	16	25	32
		A	16	23	27	
		A	16	20	23	
		A	13	16	20	
		A	9	11	13	
		A	6	8	10	
		A	3	4	5	
2 poles in series + 2 poles parallel		A	29	45	58	
A2+2		A	29	45	50	
		A	16	23	27	
		A	16	20	23	
		A	13	16	20	
		A	9	11	13	
		A	6	8	10	
	A	3	4	5		
3 poles in series	A	16	25	32		
A3	A	16	25	32		
	A	16	25	32		
	A	16	25	32		
	A	16	25	32		
	A	16	25	32		
	A	12	14	16		
	A	9	11	13		
3 poles in series + 2 poles parallel	A	29	45	58		
A3+2	A	29	45	50		
	A	29	38	45		
	A	29	38	45		
	A	29	38	45		
	A	29	38	45		
	A	12	14	16		
	A	9	11	13		
4 poles in series	A	16	25	32		
A4	A	16	25	32		
	A	16	25	32		
	A	16	25	32		
	A	16	25	32		
	A	16	25	32		
	A	16	25	32		
	A	16	25	32		
	A	16	20	23		
4 poles in series + 2 poles parallel	A	29	45	58		
A4+2	A	29	45	58		
	A	29	45	58		
	A	29	45	58		
	A	29	45	58		
	A	29	45	58		
	A	29	45	58		
	A	29	45	58		
	A	29	45	50		
	A	16	20	23		
Rated operational current I_e						
AC21B	A2, A4	U_e max. 440V	A	16	25	32
	A2+2	U_e max. 440V	A	29	45	58

1) Suitable at overvoltage category I to III, pollution degree 3 (standard-industry): $U_{imp} = 8kV$.

2) Suitable at overvoltage category I to III, pollution degree 2 (min. IP55): $U_{imp} = 8kV$.





Technical Datas

Data according to IEC 60947-3, VDE 0660, GB14048.3 (CCC China)



Main contacts		Type	LS16	LS25	LS32	
Rated operational current I_e	500V	A	1	1,25	1,5	
DC22B	600V	A	0,5	0,75	1	
L/R = 2,5ms	A1	A	0,3	0,4	0,5	
		A	0,15	0,2	0,25	
	2 poles in series	A	7	8	9	
	A2	A	5,5	6	6,5	
	800V	A	2	2,5	3	
	1000V	A	1	1,5	2	
	3 poles in series	A	16	25	27	
	600V	A	16	23	25	
	800V	A	6,5	7	7,5	
	1000V	A	5,5	6	6,5	
	4 poles in series	A	16	25	32	
	500V	A	16	25	27,5	
	600V	A	16	25	27,5	
	800V	A	11,5	12	12,5	
	1000V	A	8	9	10	
	Rated conditional short-circuit current		kA _{eff}	5	5	5
Max. fuse size	gL (gG)	A	40	63	80	
Mechanical life		x10 ³	10	10	10	
Rated short-time withstand current (1s)	I_{cw}	A2, A4, A6, A8	A	800	900	1000
		A2+2, A3+2, A4+2	A	1300	1500	1700
Short circuit making capacity	I_{cm}	A2, A4, A6, A8	A	800	900	1000
		A2+2, A3+2, A4+2	A	1300	1500	1700
Maximum cable cross sections	(incl. jumper LSV-B1)					
solid or stranded		mm ²	4 - 16	4 - 16	4 - 16	
flexible		mm ²	4 - 10	4 - 10	4 - 10	
flexible (+ multicore cable end)		mm ²	4 - 10	4 - 10	4 - 10	
Size of terminal screw			M4 Pz2	M4 Pz2	M4 Pz2	
Tightening torque		Nm	1,2 - 1,8	1,2 - 1,8	1,2 - 1,8	
Maximum ambient temperature						
Operation	open	°C		-40 to +65		
	enclosed	°C		-40 to +45		
Storage		°C		-50 to +90		
Power loss per switch at I_e max. DC21B		W				
A2		W	2	5	8	
A4		W	4	10	16	
A6		W	6	15	24	
A8		W	8	20	32	
A2+2		W	3,5	8,5	14	
A3+2		W	5,5	13	21	
A4+2		W	7	17	28	

Technical Datas

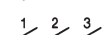
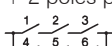
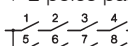
Data acc. to UL508  File E332938, Category no.: NRNT2, NRNT8

Type				LS16	LS25	LS32
Ampere-Rating "General use"						
1 pole	350V	A		4	5	6
	500V	A		4	5	6
	600V	A		4	5	6
2 poles in series	350V	A		16	20	25
	500V	A		16	20	25
	600V	A		16	20	25
2 poles in series + 2 poles parallel	350V	A		29	45	58
	500V	A		29	38	40
	600V	A		21	23	25
3 poles in series	350V	A		16	25	32
	500V	A		16	25	32
	600V	A		16	25	32
4 poles in series	350V	A		16	25	32
	500V	A		16	25	32
	600V	A		16	25	32
3 poles in series + 2 poles parallel	350V	A		29	45	58
	500V	A		29	38	50
	600V	A		21	38	45
4 poles in series + 2 poles parallel	350V	A		29	45	58
	500V	A		29	45	58
	600V	A		29	45	50
Fuse size (RK5) Industrial Control Switch 5kA / 600V	A			40	60	80
Maximum cable cross sections (incl. jumper LSV-B1)						
solid or stranded	AWG			12 - 10	12 - 10	12 - 10
flexible	AWG			12 - 6	12 - 6	12 - 6
flexible (+ multicore cable end)	AWG			12 - 6	12 - 6	12 - 6
Size of terminal screw				M4 Pz2	M4 Pz2	M4 Pz2
Tightening torque	lb.inch			11 - 16	11 - 16	11 - 16

Approvals

Country	USA, Canada UL	Europe	China CCC	CB/CCA- Certificates
Type				
LS16	o	/	o	o
LS25	o	/	o	o
LS32	o	/	o	o

o In standard version approved
- Not provided for test till now

/ No testing required CE

x In test

Dimensions

LS16 E., LS25 E., LS32 E.,
..A2

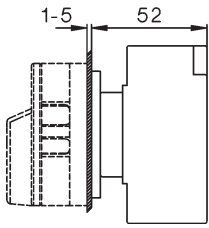

..A2+2, ..A4.

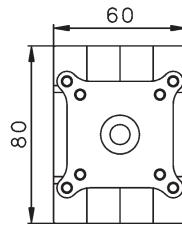
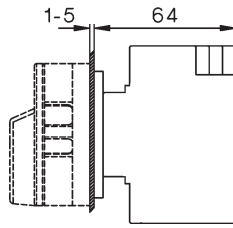

LS... +VW"x"
Extended Switch Shaft

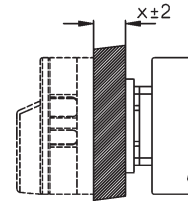

LS16 E., LS25 E., LS32 E.,
..A6, ..A8, ..A3+2, ..A4+2

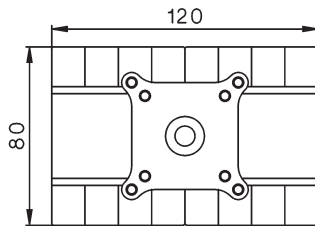
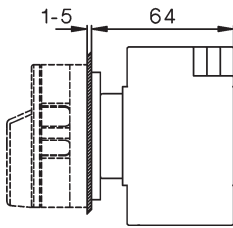

Mounting holes

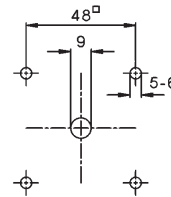

Escutcheon plate 64[□]

Handle

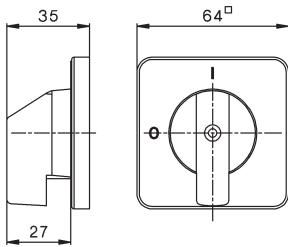

Padlock device SV1.

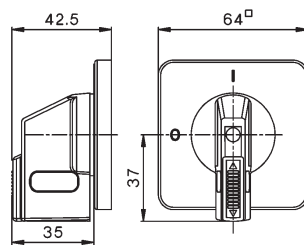

Padlock device SV4.

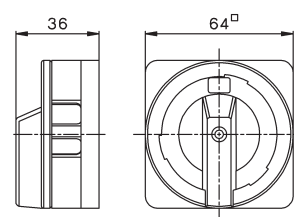

LS16 Z., LS25 Z., LS32 Z.,
..A2

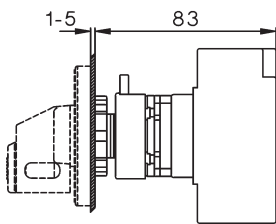

..A2+2, ..A4.

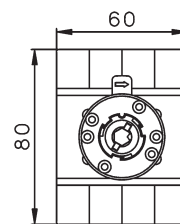
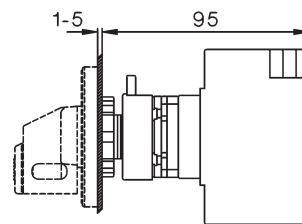
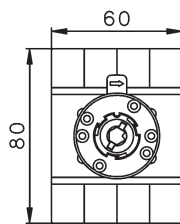

Mounting hole

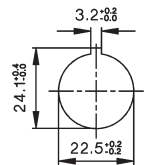

LS16 Z., LS25 Z., LS32 Z.,
..A6, ..A8, ..A3+2, ..A4+2

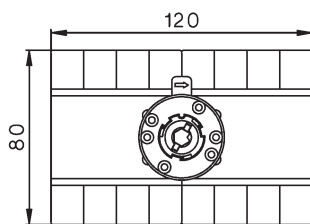
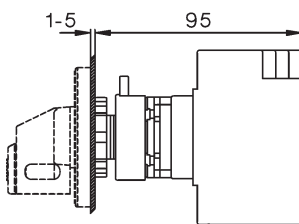

LS.. ZO..

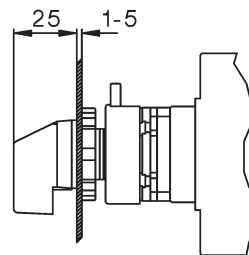

LS.. ZOH1..,

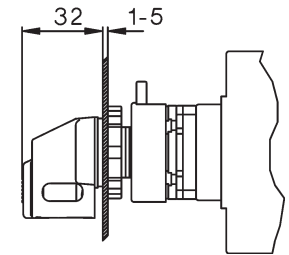

Dimensions

LS16 VZV.., LS25 VZV.., LS32 VZV..,

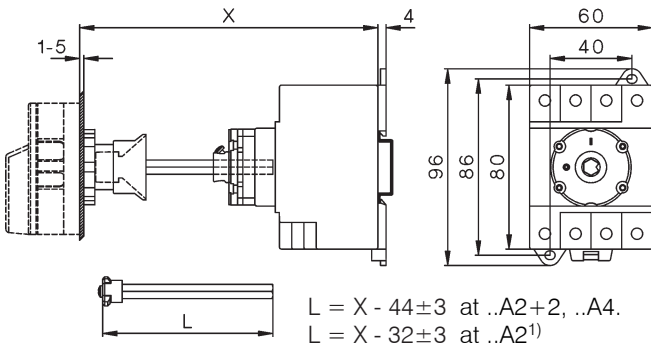

delivered with: ..A2+2, ..A4. :

$X_{max.} = 194, L = 150$

($X_{min.} = 95$)

delivered with: ..A2

$X_{max.} = 182, L = 150$

($X_{min.} = 83$)

greater X-Dimensions on request

LS16 VZV.., LS25 VZV.., LS32 VZV..,
..A6, ..A8, ..A3+2, ..A4+2

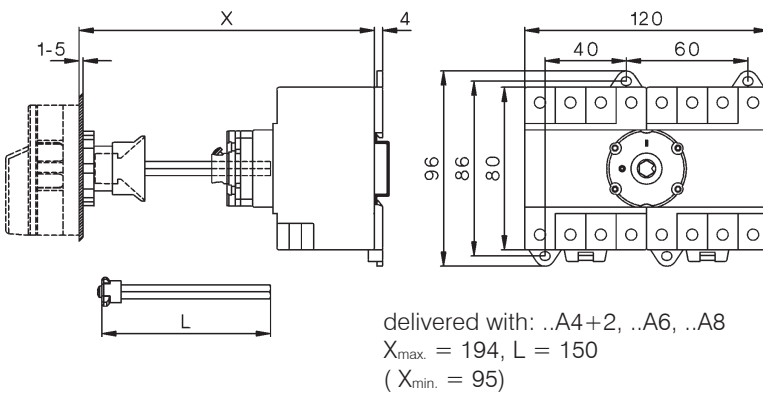

Mounting hole

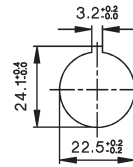

LS16 SMA.., LS25 SMA.., LS32 SMA..,
..A2 ..

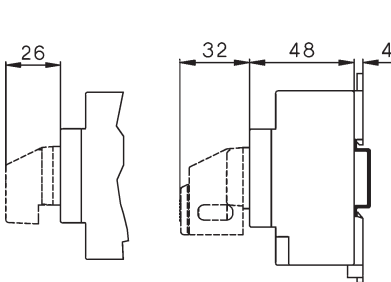

A2+2, ..A4.

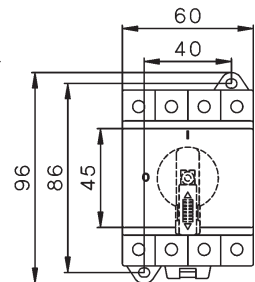
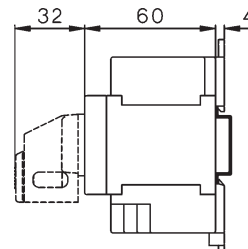
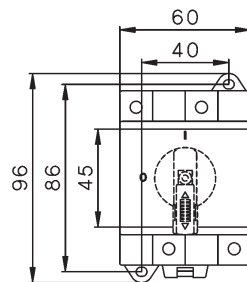

LS16 SMA.., LS25 SMA.., LS32 SMA..,
..A6, ..A8, ..A3+2, ..A4+2

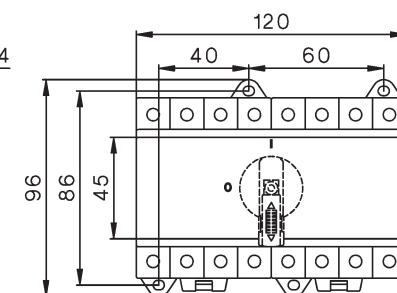
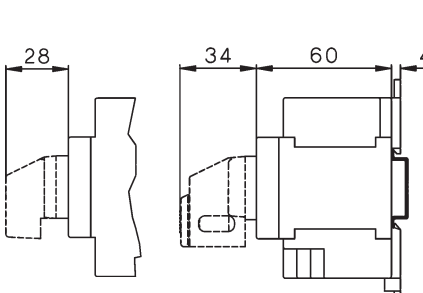

Dimensions:

LS16 PFL., LS25 PFL., LS32 PFL..
..A2, ..A2+2, ..A4.

LS16 PF., LS25 PF., LS32 PF.,
..A2, ..A2+2, ..A4.

Main-Switch (lockable)
LS..PFLH4 A..

ON-OFF-Switch
LS..PFL A..LS..PFH4 A..

Main-Switch (lockable)
LS..PFH4 A..

ON-OFF-Switch
LS..PF A..

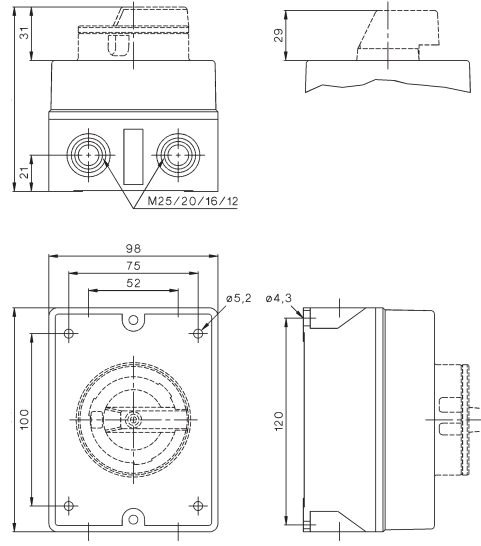
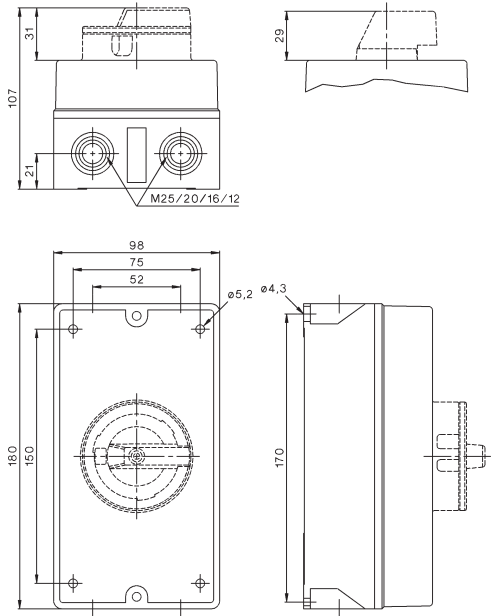

LS16 PF., LS25 PF., LS32 PF.,
..A6, ..A8, ..A3+2, ..A4+2

Main-Switch (lockable)
LS..PFH4 A..

ON-OFF-Switch
LS..PF A..

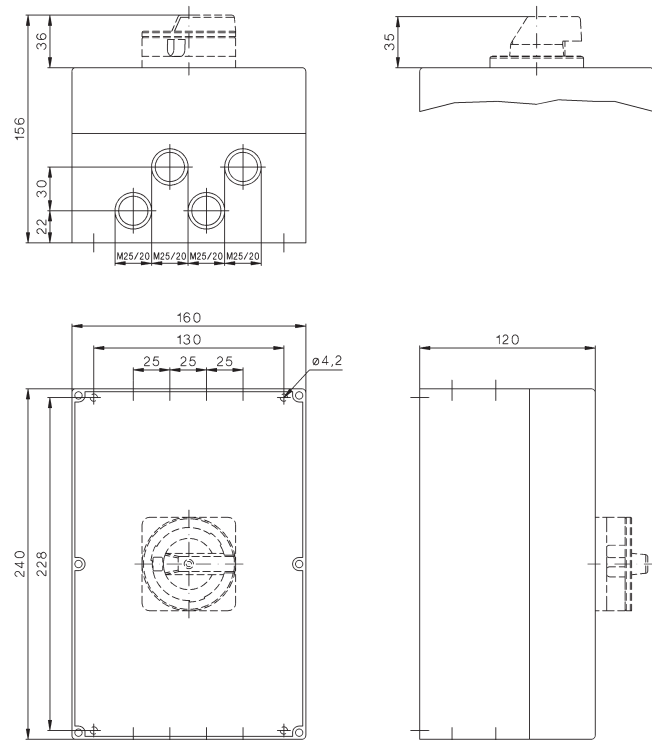



D836E131



Lieblgasse 7, A-1220 Vienna
Phone: +43 (0) 1 251 51- 0
Fax: +43 (0) 1 251 51-89
e-mail: sales@benedict.at
www.benedict.at

